





KITCHEN ESSENTIALS



SD EXPORTS
SATISFYING DEMAND



 +91 9865931583

 purchasing@sdexportsindia.com

 India

the essentials in trays

Camtread® Trays

- The original standard. "Often imitated, never duplicated".
- Non-skid surface ensures drinks and meals stay in place during transport.
- Made of heavy-duty, highly durable fiberglass with a thick molded-in, non-skid surface.
- 5 year warranty against delamination under normal usage.



Colours:

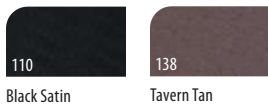

| CODE | DESCRIPTION |
|------|-------------|
|------|-------------|

| Rectangular - High Profile Shape | |
|--|-------------------|
| 2700CT | Oval 56 x 68,5 cm |
| Colours: Black (110), Tavern Tan (138). | |
| Note: Not recommended for heated cart. | |

| CODE | DESCRIPTION |
|------|-------------|
|------|-------------|

| Rectangular - High Profile Shape | |
|--|--------------------------|
| 1418CT | Rectangular 36 x 46 cm |
| 1622CT | Rectangular 40,5 x 65 cm |
| 1826CT | Rectangular 45 x 65 cm |
| Round - High Profile Shape | |
| 1400CT | Round ø 35,5 cm |
| 1600CT | Round ø 40,5 cm |
| Colours: Black (110), Tavern Tan (138). | |
| Note: Not recommended for heated cart. | |

Treadlite™ Trays

- An economical alternative to Camtread Trays.
- Non-skid surface puts a firm grip on beverages and service items.
- Reduces spillage and breakage.
- 1 year warranty against delamination under normal usage.



TECHNICAL TEST RESULTS

| | |
|------------------------|------|
| – Chemical Resistance: | ★★★★ |
| – Drying Test: | ★★★★ |
| – Shock Resistance: | ★★★★ |
| – Break Resistance: | ★★★★ |
| – Scratch Resistance: | ★★★★ |
| – Stain Resistance: | ★★★★ |

RECOMMENDED USE

| |
|-----------------------------|
| High Traffic / Frequent Use |
| – Banquet Service |
| – Restaurants / Cafes |
| – Bars / Clubs / Pubs |
| – Catering |
| – Brasseries |



TECHNICAL TEST RESULTS

| | |
|------------------------|------|
| – Chemical Resistance: | ★★★★ |
| – Drying Test: | ★★★★ |
| – Shock Resistance: | ★★★★ |
| – Break Resistance: | ★★★★ |
| – Scratch Resistance: | ★★★★ |
| – Stain Resistance: | ★★★★ |

RECOMMENDED USE

| |
|-----------------------------|
| High Traffic / Frequent Use |
| – Banquet Service |
| – Restaurants / Cafes |
| – Bars / Clubs / Pubs |
| – Catering |
| – Brasseries |

TECHNICAL TEST RATINGS KEY

| | |
|-----------|-------|
| Excellent | ★★★★★ |
| Very Good | ★★★★ |
| Good | ★★★ |



Colours:



| CODE | DESCRIPTION |
|------|-------------|
|------|-------------|

| | |
|--------|--------------------------|
| 1400TL | Round ø 35,5 cm |
| 1600TL | Round ø 40,5 cm |
| 1418TL | Rectangular 36 x 46 cm |
| 1520TL | Rectangular 38 x 51,5 cm |
| 1622TL | Rectangular 40,5 x 56 cm |

Colours: Black (110), Tavern Tan (138).

1400TL Colour: Tavern Tan (138).

the essentials in trays

Fast Food Trays

- Perfect for self-serve, quick-serve dining in schools, colleges or restaurants.
- Made of highly durable, long lasting polypropylene.
- Attractive textured surface hides scratches.



High Profile Shape

Colours:

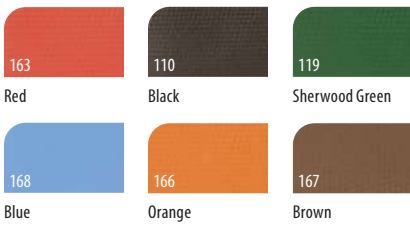

TECHNICAL TEST RESULTS

| | |
|------------------------|-------|
| – Chemical Resistance: | ★★★★★ |
| – Drying Test: | ★★★★★ |
| – Shock Resistance: | ★★★★★ |
| – Break Resistance: | ★★★★★ |
| – Scratch Resistance: | ★★★★★ |
| – Stain Resistance: | ★★★★★ |

RECOMMENDED USE

High Traffic / Frequent Use

- Quick Serve Restaurants
- Food Courts
- Snack Shops



1014FF

| CODE | OUTER DIMENSIONS |
|---|------------------|
| Rectangular - High Profile Shape | |
| 1216FF | 30 x 41 cm |
| 1418FF | 36 x 46 |

1418FF Colours: Red (163), Brown (167).
Note: Wash daily for 60 seconds to a maximum temperature of 80° C.



| CODE | OUTER DIMENSIONS |
|-----------------------------------|------------------|
| Rectangular - With Handles | |
| 1113FFH | 27,9 x 33 cm |
| 1317FFH | 33 x 43 |

1113FFH and 1317FFH Colours: Black (110), Sherwood Green (119), Red (163), Orange (166), Brown (167), Navy Blue (186).
Note: Wash daily for 60 seconds to a maximum temperature of 80° C.



the essentials in trays

Separator Compartment Trays with Lid

- 6-compartment tray designed specifically for in-cell feeding programs.
- Tray with cover separates each compartment to retain food temperature and reduce spills.
- Locking ridges on top of cover and bottom of tray ensure more secure stacking.



10146DCW

Colours:



10146DCW tray
with 10146DCWC Lid.



| CODE | DESCRIPTION | OUTER DIMENSIONS |
|------------------------------|------------------|--------------------|
| Camwear Polycarbonate | | |
| 10146DCW | 6 Compartments | 25,4 x 36 x 2,9 cm |
| 10146DCWC | Lid for 10146DCW | – |
| Co-Polymer | | |
| 1411CP | 5 Compartments | 36,5 x 26,8 x 3,3 |

10146DCW Colour: Beige (133), Brown (167).

10146DCWC Colour: Clear (135).

1411CP Colours: Tan (161), Brown (167).

Compartment Trays for UPC400

- 6 compartments designed specifically to transport and serve hot/cold Indian food.
- Fits in UPC400 – 24 No's.

| CODE | DESCRIPTION | OUTER DIMENSIONS | CASE PACK |
|----------|-------------------------|------------------|-----------|
| 11136IT | 6 Compartments | 28 x 33 cm | 24 |
| 11136CIT | 6 Compartments with Lid | 28 x 33 | 24 |

Tray Colours: Sherwood Green (119), Red (163), Navy Blue (186), White (148).

Lid Colour: Translucent (190)

Material: PPCP – FDA approved material.

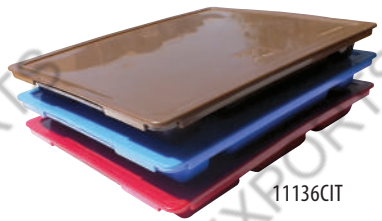

11136CIT

the essentials in table service

12CWNR / 12CWNRP Camwear® Dinner Plate

**Now Available in Plain Surface (12CWNRP)
and Textured Surface (12CWNR)**

Features:

- Virtually unbreakable Camwear resists stains, odors, and scratches.
- Textured surface on dinner plates reduces wear.

**825CWNR/825CWNRP Quarter Plate now Available in Plain
Surface (825CWNRP) and Textured Surface (825CWNR)**

Features:

- Virtually unbreakable Camwear resists stains, odors, and scratches.
- Ideal for school, cafeterias, day care centres and healthcare facilities.



12CWNRP

825CWNRP



| CODE | Ø DIAMETER | CASE PACK |
|------------|------------|-----------|
| 12CWNRP | 31,5 cm | 24 |
| 825CWNR(P) | 21 | 24 |

Colours: White (148), Beige (133).

7CW Camwear Bowl

Features:

- Virtually unbreakable Camwear resists stains, odors, and scratches.
- Ideal for school, cafeterias, day care centres and healthcare facilities.



7CW



| CODE | Ø DIAMETER | CAPACITY | CASE PACK |
|------|------------|----------|-----------|
| 7CW | 4,4 cm | 220 mL | 48 |

Colours: White (148), Beige (133).

the essentials in table service

Camwear® Polycarbonate Dinnerware

- Virtually unbreakable Polycarbonate resists stains, odors and scratches.
- Ideal for schools, cafeterias, day care centers and healthcare facilities.



| CODE | DESCRIPTION | QUANTITY |
|---------------|----------------------|----------|
| Plates | | |
| 9CWNR | Narrow Rim | 48 |
| Bowls | | |
| 10CW | Square Bowl, 278 mL | 48 |
| 35CW | Bouillon, 252 mL | 48 |
| 45CW | Fruit Cup, 150 mL | 48 |
| 50CW | Nappie Bowl, 452 mL | 48 |
| Mugs | | |
| 75CW | Stacking Cup, 239 mL | 48 |

9CWNR, 10CW, 35CW, 45CW and 50CW Colour: White (148).
75CW Colours: Beige (133) and White (148).



Polycarbonate Camcovers®

- Food stays hot and appetizing without re-heating.
- Ideal for use in heated carts.
- Safe up to 99°C.
- Virtually unbreakable polycarbonate will not dent or scratch.
- Lightweight for quiet service.
- Saves on labor with no polishing required.



| CODE | DIAMETER | HEIGHT |
|--------|-----------|--------|
| 1202CW | ø 30,8 cm | 7,0 cm |

Colour: Clear (152).



Polycarbonate Pitchers

- Made of Polycarbonate.
- Virtually unbreakable.
- Will not bend or chip.
- Ergonomic handle.
- Slotted base helps drain water after washing for a complete and sanitary drying.



| CODE | Ø WITH HANDLE | CAPACITY |
|---------|---------------|----------|
| P480CW | 14,5 cm | 1,4 L |
| PE600CW | 24,8 | 1,8 |
| PC64CW | 17 | 1,9 |

Colour: Clear (135).



the essentials in table service

Polycarbonate Aliso® Barware

- Replicates the look, heft and clarity of glass with virtually unbreakable polycarbonate.
- Sleek design and durability for casual dining, outdoor events and poolside service.
- Chill or frost barware without concerns of thermal shock damage.



| CODE | CAPACITY | QUANTITY |
|----------|------------------|----------|
| BWM10CW | Martini 310,5 mL | 12 |
| BWW10CW | Wine 310,5 mL | 24 |
| BWP14CW | Pilsner 458,4 mL | 24 |
| BWB16CW | Beer 473 mL | 12 |
| GB1200CW | Goblet 378 mL | 24 |

Colour: Clear (135).



BWM10CW



BWP14CW



BWB16CW

Polycarbonate Huntington Tumblers

- Offers the elegant look of glass with the virtually unbreakable durability of polycarbonate.
- Light weight, easy to carry.
- Drain bottom for easy washing and drying.
- Stackable.



| CODE | CAPACITY | QUANTITY |
|---------|----------|----------|
| HT5CW | 148 mL | 36 |
| HT8CW | 237 | 36 |
| HT10CW | 296 | 36 |
| HT120CW | 355 | 36 |
| HT16CW | 473 | 36 |

Colour: Clear (135).



the essentials in table service

Laguna® SAN Tumblers

- Made of impact-resistant SAN plastic.
- Textured exterior surface reduces scratching.
- Lightweight, easy to carry.
- Stackable.



| CODE | CAPACITY | QUANTITY |
|------|----------|----------|
| LT8 | 236,6 mL | 36 |
| LT10 | 295,7 | 36 |
| LT12 | 354,9 | 36 |

Colour: Clear (152).



Colorware SAN Tumblers

- Made of impact-resistant SAN plastic.
- Textured exterior surface reduces scratching.
- Lightweight, easy to carry.
- Stackable.



| CODE | CAPACITY | QUANTITY |
|-------|----------|----------|
| 500P | 231 mL | 72 |
| 800P | 231 | 72 |
| 950P | 290 | 72 |
| 1200P | 373 | 72 |

Colour: Clear (152).



CamView® Camliter Beverage Decanters

- Made of impact resistant material.
- Withstands temperature from -40° to 76°C.
- Light-weight, dent and scratch resistant.
- Spill-proof, snap tight flat lids included to protect content from cross contamination.
- Pour Spout Lid available to protect content while allowing free pour.



| CODE | HEIGHT | CAPACITY |
|--------------------------------|-------------------|----------|
| Camliters with Flat Lid | | |
| WW1500 | 25,4 cm | 1,5 L |
| WW1000 | 24,8 | 1,0 L |
| WW500 | 20,0 | 0,5 L |
| WW250 | 20,0 | 0,25 L |
| Pour Spout Lid | | |
| WW1000LS | Fits 1 L or 0,5 L | |

Colour: Clear (135).

Lid Colour: White (148).



the essentials in display

Polycarbonate Cover & Tray

- Display covers protect freshness of pastries, breads and desserts.
- Virtually unbreakable Camwear polycarbonate features the upscale look of glass.



| CODE | DESCRIPTION | DIMENSIONS |
|----------|--------------|----------------|
| DT1220CW | Display Tray | 30,5 x 50,8 cm |

DT1220CW Colour: Black (110).



RD1220CW



DT1220CW

Polycarbonate Tongs & Ladles

- Polycarbonate, virtually unbreakable.
- Will not bend or dent.
- Wide handle for a secure grip.
- Thumb rest provides a comfortable, firm grip.
- Hole for hanging.



| CODE | DESCRIPTION | LENGTH |
|-------|-------------|---------|
| LD85 | Plain Ladle | 21,6 cm |
| LD105 | Plain Ladle | 26,8 |

Colour: Black (110).

| CODE | DESCRIPTION | LENGTH |
|-------|-------------------|--------|
| TG6* | Flat Grip Tong | 15 cm |
| 9TGS | Scallop Grip Tong | 23 |
| TGA8 | Angled Tong | 21 |
| TGA11 | Angled Tong | 27,5 |
| TGG6 | Easy-Grasp Tong | 15 |
| TGG9 | Easy-Grasp Tong | 24 |

Colours: Black (110), Clear (135), White (148).

***TG6 Colour:** Black (110) only.



Camwear® Polycarbonate Shakers

- Clear virtually unbreakable Camwear® polycarbonate and color coded lids make it easy to identify contents.
- A staple in the kitchen, at the condiment station or on the dining table.



| CODE | DESCRIPTION | LID COLOR |
|--------|----------------------|--------------|
| 96SKRF | w/ fine ground lid | Green (407) |
| 96SKRP | w/ parsley lid | White (148) |
| 96SKRD | w/ salt & pepper lid | Beige (406) |
| 96SKRC | w/ cheese lid | Yellow (405) |
| 96SKRM | w/ medium ground lid | Rose (408) |

Colour: Clear (135).

Lid Colour: Beige (406).



the essentials
in storage

Camshelving

BASICS PLUS SERIES®



-38° to 88°C



innovative,
strong composite material
withstands all elements



- designed for all areas of food service operations.
- ideal for wet, dry, cold or hot environments.
- withstands temperatures as cold as -38°C or warm environments up to 88°C.
- resistant to moisture; won't rust or corrode.

smart design

- designed with flexibility to fit into any space.
- shelf plates are easily removed for thorough dishwasher cleaning.
- non-porous surface simply wipes clean.

uncompromised reliability

- composite material is as strong as steel and twice as strong as aluminum.
- up to 60% lighter in weight than steel; easy to set up, adjust and change configurations.
- ideal for freezers, walk-in coolers, any wet or humid environment or dry storage room.



COMPONENT

exceptional value

- impervious to moisture, salt and chemicals.
- won't peel, dent or warp; remains rust-free.
- lifetime warranty against corrosion and rust.

weight capacity

| | traverse length (mm) | US self certification weight bearing capacity | | TÜV certification weight bearing capacity | |
|----------------------------|----------------------|---|----------|---|----------|
| | | per shelf | per unit | per shelf | per unit |
| single unit (4 shelves) | 765 - 915 | 272 kg | 1089 kg | 300 kg | 1200 kg |
| | 1070 - 1220 | 272 | 1089 | 250 | 1000 |
| | 1375 - 1525 | 227 | 907 | 200 | 800 |

| | | | |
|----------------------------|-----------|--------|--------|
| corner unit (4 shelves) | 765- 1220 | 136 kg | 544 kg |
|----------------------------|-----------|--------|--------|

Corner Connectors are recommended for use on traverses 1220 mm or less.

Camshelving Basics is available in different configurations to fit every need:

Available in combinations of three heights (1630 mm, 1830 mm and 2140 mm);
3 widths (460 mm, 540 mm and 610 mm);
and six shelf lengths (765 mm, 915 mm, 1070 mm, 1220 mm, 1375 mm and 1525 mm).



Starter Unit



Starter Unit + Add-On Unit



Starter Unit + Corner Unit



U-Shaped Unit
(2 starter units + shelf kits)

the essentials
in storage

Camshelving

BASICS PLUS SERIES®

Stationary Post Kit

- Includes 2 stationary posts with leveling feet installed, 1 top post connector, 1 bottom post connector, 8 post connector wedges in a bag and instructions.

Stationary Post Kits

| HEIGHT | WIDTH | 540 mm | 610 mm |
|---------|-------|----------|----------|
| 1630 mm | CODE | CBPK2164 | CBPK2464 |
| 1830 mm | | CBPK2172 | CBPK2472 |

Colour: Brushed Graphite (580).

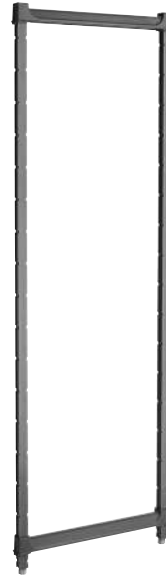

Vented Shelf Kit

- Includes vented shelf plates for 1 shelf, 2 stationary traverses, 1 bag of 8 stationary traverse dovetails (16 each A and B) and instructions.

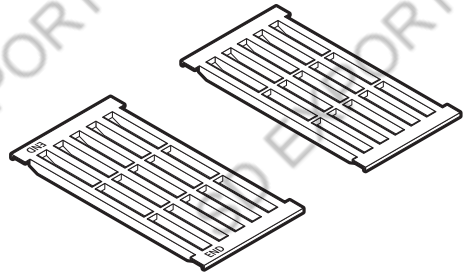

Stationary Post Kits

| WIDTH | LENGTH | 910 mm | 1220 mm | 1530 mm |
|--------|--------|------------|------------|------------|
| 540 mm | CODE | CBSK2136V1 | CBSK2148V1 | CBSK2160V1 |
| 610 mm | | CBSK2436V1 | CBSK2448V1 | CBSK2460V1 |

Colour: Brushed Graphite (580).

Corner Connectors

- Used to build corners and U-shaped units.
- Easily snap onto traverses.
- Set attaches a starter unit to an add-on unit at a 90° angle or to form a U-shape. Eliminates 1 post kit.
- A set of corner connectors are needed for each shelf.
- Corner connectors are recommended for use on traverses equal to or less than 1220 mm and up to 136 kg per shelf.



| CODE | DESCRIPTION | CASE PACK |
|-------|----------------------|-----------|
| CBCC1 | Corner Connector Set | 1 set |

Colour: Brushed Graphite (580).

Camshelving Basics Components are Patent Pending.

the essentials
in storage

Camshelving

ELEMENTS SERIES®

Ideal for use in freezer, cold room and dry storage applications

STRONG COMPOSITE MATERIAL



- Composite material is as strong as steel.
- Easy to clean; easy to set up, adjust and change configurations.
- Won't rust or corrode.
- Shared post design to maximize space.

HYGIENIC DESIGN



- Non-porous surface simply wipes clean.
- Shelf plates are easily removed for thorough dishwasher cleaning.
- Camguard® Antimicrobial protection is permanently embedded in shelf plates.
- Camguard works continuously to suppress the growth of microbes between cleanings.

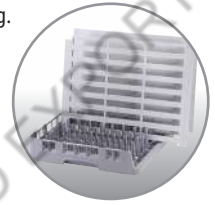

SHELVING FOR LIFE



- Lifetime warranty against corrosion and rust.
- Withstands temperatures as cold as -38°C or warm environments up to 88°C.
- Ideal for wet, dry, cold or frozen environments.
- Impervious to moisture and chemicals.
- Won't peel, dent or warp; remains rust-free.

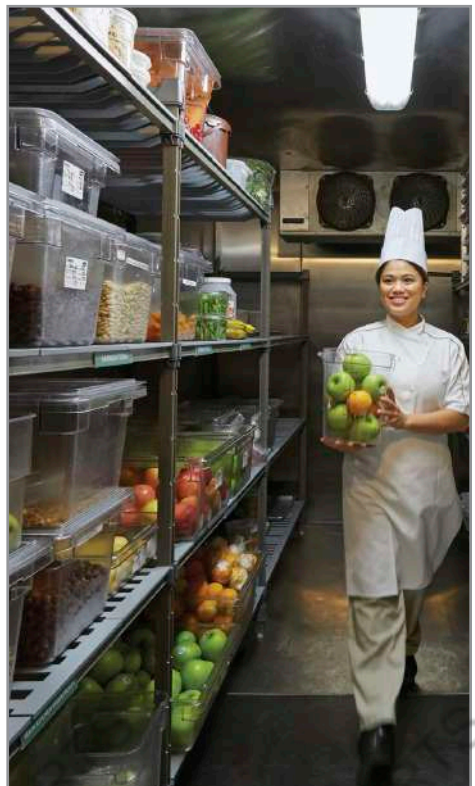

the essentials
in storage

Camshelving

ELEMENTS SERIES®

Easy To Adjust – Build Any Configuration
And Maximize Storage Space In Any Area

- Create a space efficient layout for any area.
- Assembles requiring only the use of a rubber mallet.
- Shelves can be adjusted in 100 mm increments without disassembling the entire unit.
- Corner Connectors attach units to create a 90° angle or U-shape.
- Two units can be connected together by sharing posts with corner connectors with shelves at alternating heights for maximum storage flexibility, without loss of weight bearing capacity.

Starter Unit

Starter units include 2 factory assembled post kits and shelves.

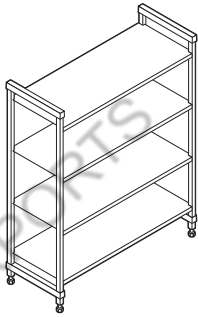

Add-on Unit

Shared posts between starter unit and add-on unit maximize space.

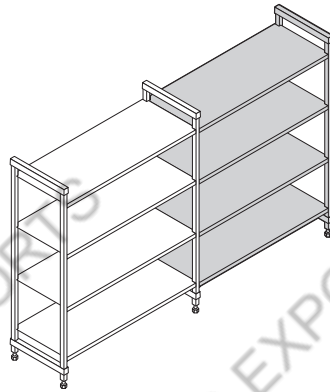

Corner Unit

Requires one set of Corner Connectors per shelf.

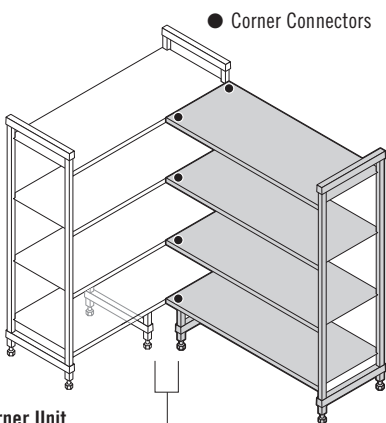

Corner Unit

Starter + Add-On Unit using 1 set of Corner Connectors per shelf and 2 Dunnage Stands.

U-Shaped Unit

Requires two sets of corner connectors per shelf.

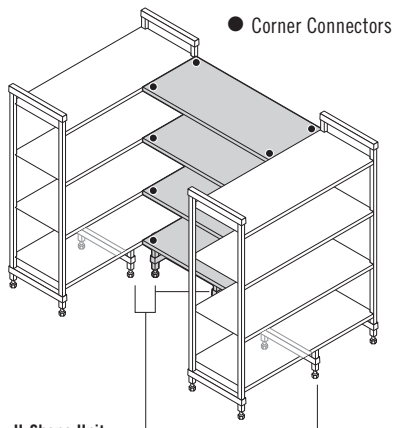

U-Shape Unit

Two Starter Units + Intermediate Shelves using 2 sets of Corner Connectors per shelf and 4 Dunnage Stands.

the essentials
in storage

Camshelving

ELEMENTS SERIES®

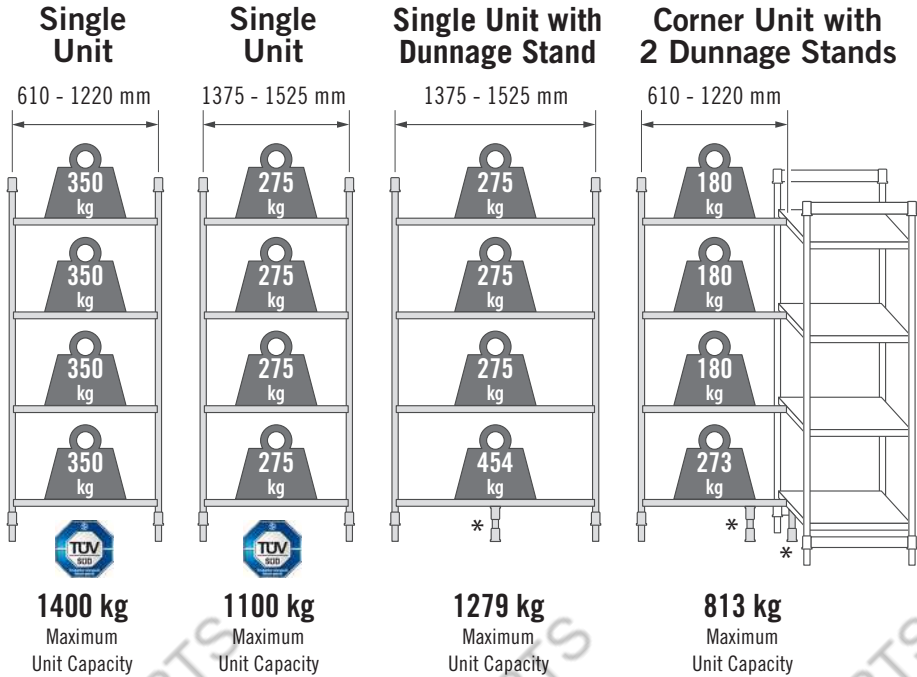

* Dunnage Stands add stability and increase weight bearing capacity on bottom shelf only. Add to any shelf length. Highly recommended for Starter Units 1375 mm and longer, all Corner Units, U-Shape Units and units specified for heavier loads
 ** Due to the weight bearing capacity of casters, maximum weight load on an entire Mobile Unit is 340 kg.

Stationary Post Kit

- Includes 2 stationary posts with leveling feet installed, 1 top post connector, 1 bottom post connector, 8 post connector wedges in a bag and instructions.



Stationary Post Kits

| HEIGHT | WIDTH | 540 mm | 610 mm |
|---------|-------|---------|---------|
| 1630 mm | CODE | EPK2164 | EPK2464 |
| 1830 mm | | EPK2172 | EPK2472 |

Colour: Brushed Graphite (580).

Vented Shelf Kit

- Includes vented shelf plates for 1 shelf, 2 stationary traverses, 1 bag of 8 stationary traverse dovetails (16 each A and B) and instructions.



Stationary Post Kits

| WIDTH | LENGTH | 1220 mm | 1830 mm |
|--------|--------|-----------|-----------|
| 540 mm | CODE | ESK2148V1 | ESK2172V1 |
| 610 mm | | ESK2448V1 | ESK2472V1 |

Colour: Brushed Graphite (580).

the essentials in storage

CamSquare® Polycarbonate Food Storage Containers



- Space efficient storage containers.
- Made of virtually unbreakable polycarbonate.
- Crystal clear for identification at a glance.



| CODE | CAPACITY | DIMENSIONS L x W x H |
|----------|----------|----------------------|
| 2SFSCW | 1,9 L | 18,5 x 18,5 x 10 cm |
| 4SFSCW | 3,8 | 18,5 x 18,5 x 18,7 |
| 6SFSCW | 5,7 | 21,5 x 21,5 x 18,5 |
| 8SFSCW | 7,6 | 21,5 x 21,5 x 23 |
| 12SFSCW* | 11,4 | 25,6 x 31 x 21 |
| 18SFSCW* | 17,2 | 25,6 x 31 x 32 |
| 22SFSCW* | 20,8 | 25,6 x 31 x 40 |

Colour: Clear (135).

Lid Colours: SFC2, SFC6, SFC12, Winter Rose (451), Kelly Green (452).

* Dimensions include handles.

| CODE | FITS |
|--------------------|---------------------|
| Seal Covers | |
| SFC2SCPP | 1,9 & 3,8 L |
| SFC6SCPP | 5,7 & 7,6 L |
| SFC12SCPP | 11,4, 17,2 & 20,8 L |

Colour: Translucent (190).



the essentials in storage

Polycarbonate Clear Gastronorm Food Pans

- Store, transport and serve all-in-one.
- Gastronorm dimensions to fit in standard prep tables.
- Smooth interior offers high yield and makes pans easy to clean, saving time.
- Made of virtually unbreakable polycarbonate to ensure that they won't crack, bend, or dent.
- Withstand temperatures from -40°C to 99°C.
- Standard and Metric measurements molded in to promote easy inventory management.



| GN | DEPTH 65 mm | CAPACITY | DEPTH 100 mm | CAPACITY | DEPTH 150 mm | CAPACITY | DEPTH 200 mm | CAPACITY | DRAIN SHELF |
|-----|----------------|----------|-----------------|----------|-----------------|----------|-----------------|----------|----------------|
| 1/1 | 12CW | 8,5 L | 14CW | 13,0 L | 16CW | 19,5 L | 18CW | 25,6 L | – |
| 1/2 | 22CW | 3,9 | 24CW | 5,9 | 26CW | 8,9 | 28CW | 11,7 | 20CWD |
| 1/3 | 32CW | 2,4 | 34CW | 3,6 | 36CW | 5,3 | 38CW | 6,9 | 30CWD |
| 1/4 | – | – | 44CW | 2,5 | 46CW | 3,7 | – | – | – |
| 1/6 | 62CW | 1 | 64CW | 1,5 | 66CW | 2,2 | – | – | 60CWD |
| 1/9 | 92CW | 0,57 | 94CW | 0,85 | – | – | – | – | 90CWD |

12CW, 22CW, 32CW, 62CW, 92CW, 14CW, 24CW, 34CW, 44CW, 64CW, 46CW, 18CW, 28CW, 38CW, 20CWD, 30CWD, 60CWD, 90CWD Colour: Clear (135). 94CW, 16CW, 26CW, 36CW, 66CW Colours: Black (110), Clear (135).



| GN | COVER WITH HANDLE | FLAT COVER | GRIPLID® | SEAL COVER |
|-----|-------------------|------------|----------|------------|
| 1/1 | 10CWCH | 10CWC | 10CWGL | 10PPCWSC |
| 1/2 | 20CWCH | 20CWC | 20CWGL | 20PPCWSC |
| 1/3 | 30CWCH | – | 30CWGL | 30PPCWSC |
| 1/4 | 40CWCH | 40CWC | – | 40PPCWSC |
| 1/6 | 60CWCH | 60CWC | – | 60PPCWSC |
| 1/9 | – | 90CWC | – | 90PPCWSC |

Colour: Clear (135).

Seal Cover Colour: Sheer Blue (438).

the essentials in storage

High Heat H-Pans™ Gastronorm Food Pans

- Reduce handling and save expense with one pan that can go from prep to cooler to oven to steam table.
- Gastronorm dimensions to fit in standard prep tables.
- Not recommended for high heat cooking in: microwaves, convection ovens, combi ovens, grills, finishing ovens, high speed ovens or ranges.
- Ideal for heated carts, steam tables and chafing dishes.
- Made from FDA approved materials that withstand extreme temperatures from -40°C to 149°C.
- Metric measurements molded in to promote easy inventory management.
- Non-stick smooth interior surface increases yields and promotes easy cleaning.



HALF SIZE LONG

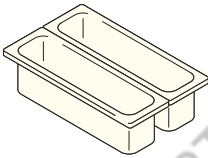

HALF SIZE

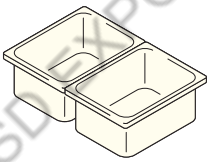

| CONFIGURATIONS | PAN CODE | PAN DEPTH | APPROXIMATE CAPACITY | CASE KG (CUBE M ³) |
|-----------------------------|----------|-----------|----------------------|--------------------------------|
| GN 1/2 Long 16,2 x 53 cm | 22LPHP | 6,5 cm | 3 L | 2,64 (0,012) |
| | 24LPHP | 10 | 5 | 3,92 (0,028) |
| | 20LPHPD | — | Drain Shelf | 1 (0,005) |

Colour: Amber (150).

| | | | | |
|--------------------------|-------|---|-------------|--------------|
| GN 1/2 26,5 x 32,5 cm | 20HPD | — | Drain Shelf | 1,10 (0,005) |
|--------------------------|-------|---|-------------|--------------|

Colour: Amber (150).

| | | | | |
|------------------------|--------|--------|--------|--------------|
| GN 1/1 32,5 x 53 cm | 12HPH* | 6,5 cm | 8,42 L | 5,90 (0,044) |
|------------------------|--------|--------|--------|--------------|

Colour: Amber (150).

| GN | CODE | DESCRIPTION | CASE KG (CUBE M ³) |
|------|---------|-------------|--------------------------------|
| 1/1* | 10CWGL | GripLid® | 4,84 (0,032) |
| 1/2* | 20CWGL | GripLid | 2,60 (0,015) |
| 1/2† | 20LPHPC | Flat Cover | 2 (0,007) |
| 1/3 | 30CWGL | GripLid | 1,97 (0,011) |

Colours: Clear (135)*, Amber (150)†.



the essentials in storage



Ingredient Bins

- FDA approved polyethylene one-piece body.
- Transparent, polycarbonate cover reduces handling and allows for quick product identification.
- Camcrisper® is a self-contained system for storing, washing and transporting bulk produce.



| CODE | DIMENSIONS | CAPACITY |
|-------|-----------------|----------|
| IBS20 | 33 x 75 x 71 cm | 81 L |
| IBS27 | 42 x 75 x 71 | 102 |
| IBS37 | 55 x 75 x 71 | 140 |
| CC32 | 56 x 61 x 58,5 | 121 |

Colour: White (148).



Polycarbonate Scoops

- Made of clear, virtually unbreakable polycarbonate for long lasting durability.
- Molded-in sure grip handle includes a hole for hanging.
- Ideal for use with Cambro Ice Caddies and Ingredient Bins.



| CODE | CAPACITY |
|---------|----------|
| SCP6CW | 170 g |
| SCP12CW | 340 |
| SCP24CW | 680 |

Colour: Clear (135).



the essentials in storage



Polycarbonate Measuring Cups

- Made of clear, virtually unbreakable polycarbonate for easy reading.
- Long lasting durability.
- Molded-in handle will not break off.



| CODE | DESCRIPTION |
|---------|-------------|
| 25MCCW | 225 mL |
| 50MCCW | 0,5 L |
| 100MCCW | 1 L Jug |
| 400MCCW | 4 L Jug |

Colour: Clear (135).



the essentials in meal delivery

Camtainer®

Insulated 18 L Beverage Container

- One-piece polyethylene body.
- Polyurethane foam insulated.
- Molded-in handles.
- Nylon latches.
- Vent cap to equalize internal pressure and check temperature.
- Interlock and stack to ease transporting and maximize storage space.



| CODE | DIMENSIONS W x D x H | CAPACITY |
|---------|----------------------|----------|
| 500LCD | 23 x 42 x 62 cm | 18 L |
| 1000LCD | 41,5 x 53 x 63 | 44,5 |

Colours: Dark Brown (131), Slate Blue (401).



the essentials in meal delivery



Insulated Container – UPC400: To Transport GN Food Pans

- Superior performance: keep food hot or cold for up to 4 hours without electricity.
- Polyurethane foam insulation improves temperature maintenance and allows for a safe exterior compared to hot metal cabinets.
- Durable construction will never dent, rust, chip, or break.
- Built in handles for ergonomic lifting & Durability.
- Doors open 270° for easy loading and unloading of food pans.
- Units are stackable and can be placed on a dolly for transport.



UPC400



Polyurethane insulation keeps hot food hot and cold food cold.

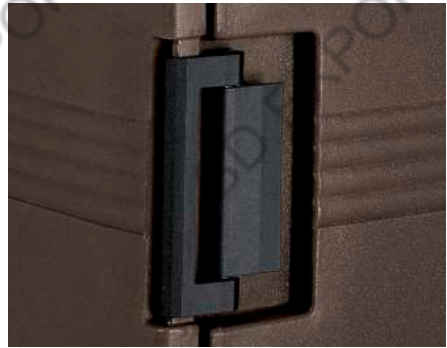

Durable nylon door latches open easily and close securely.

TRANSPORT CAPACITY

GN 1/1 FOOD PANS

UPC400

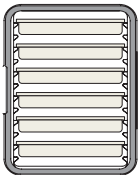

6 x 6,5 cm
Deep Pans
51,0 L

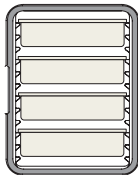

4 x 10 cm
Deep Pans
52,0 L

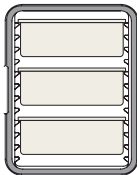

3 x 15 cm
Deep Pans
58,5 L

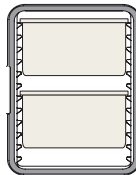

2 x 20 cm
Deep Pan
51,2 L

FOOD TEMPERATURE RETENTION

Hot

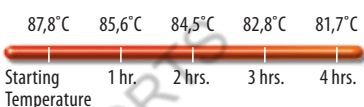

Cold

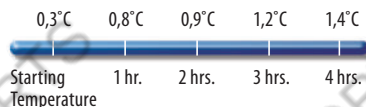

the essentials in meal delivery

Insulated Container – UPC400: (cont.)



| CODE | DESCRIPTION | COLOUR | DIMENSIONS W x D x H |
|--------|-------------|------------------------------------|----------------------|
| UPC400 | Pan Carrier | Dark Brown (131), Slate Blue (401) | 46 x 63,3 x 62 cm |
| CD400 | Camdolly® | Dark Brown (131) | 53 x 70 x 23 |
| CP1220 | Camchiller® | Cold Blue (159) | 33 x 53 x 3,8 |

UPC400 Colours: Dark Brown (131), Slate Blue (401).

CD400 Colour: Dark Brown (131).

CP1220 Colour: Cold Blue (159).

Slidinglid® Ice Caddy

- Indoors or outdoors, in heat or humidity, these high quality ice caddies perform.
- Holds ice for days!
- Polyethylene body and thick foam insulation provide durability and long lasting ice storage.
- Unique sliding lid helps reduce the risk of cross contamination.
- Recessed well and drain shelf keep ice out of water, extending holding times.
- Recessed handle on front end for easy moving and lifting.
- No assembly required.



| CODE | DIMENSIONS W x D x H | CAPACITY |
|---------|----------------------|----------|
| ICS125L | 58,5 x 80 x 74,5 cm | 57 kg |

Colours: Dark Brown (131), Slate Blue (401).

ICS125L

the essentials in meal delivery



Ultra Pan Carrier® H-Series Hot Holding Insulated Container: To Transport GN Food Pans

- The standard for all your banquet and catering needs, these units are the right choice for cost effective, energy efficient heated cabinets.
- Unlike metal cabinets, high quality, thick foam insulation retains hot temperatures for up to 4 hours unplugged and reduces unnecessary electrical usage.
- Patented vent cap design enables operators to maintain natural food moisture and quality by eliminating excess pressure and steam.
- Lightweight yet durable, these units will not bend, dent, or chip like similar metal cabinets.
- Tough polyethylene exterior remains cool to the touch, reducing the risk of employee injury.
- Lower price point than comparable metal cabinets.



Non-corrosive heating unit maintains a safe temperature range of 65°C to 74°C.



Tough, polyethylene exterior stays cool to the touch.

Molded-in handles will not break off.

Vent cap equalizes pressure and releases steam.

Removable cord stows securely for transport.



UPCH4002

UPCH4002 Hot Holding When Unplugged

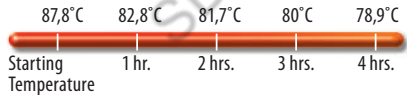

TIME & TEMPERATURE PERFORMANCE

| | | |
|------------------------|---|--------------|
| Hot Holding | Average temperature inside compartment | 65°C to 74°C |
| Warm up Time | From ambient to hot. | 45 minutes |
| Recovery Time | Time to recover to hot temperature after door is held open for 30 seconds. | 3 minutes |
| Transport Time* | After reaching hot temperature, amount of time unit can be held passively / unplugged until temperature reaches (65°C). | 4 hours + |

*Based on test with 4 full-sized, 10 cm deep H-Pans[®] filled with 87,7°C hot water.

ELECTRICAL SPECIFICATIONS

| | UPCH4002 |
|----------------------|-----------------|
| Required Voltage | 220 – 230 VAC |
| Maximum Amp. | 1.2a |
| Watts | 265w |
| Hertz | 50/60 |
| Plug Type | Euro plug, CEE7 |
| Cord Connector/Inlet | C15/C16 |
| Power Cord Length | 2,7m |

TRANSPORT CAPACITY

UPCH4002

| | | | |
|-----------------------------------|----------------------------------|----------------------------------|---------------------------------|
| | | | |
| 6 x 6,5 cm Deep Pans 51,0 L | 4 x 10 cm Deep Pans 52,0 L | 3 x 15 cm Deep Pans 58,5 L | 2 x 20 cm Deep Pan 51,2 L |

| CODE | DESCRIPTION | COLOUR | DIMENSIONS W x D x H |
|----------|--------------------------------|------------------|----------------------|
| UPCH4002 | Heated Ultra Pan Carrier, 220V | Dark Brown (131) | 46 x 67 x 63 cm |
| CD400 | Camdolly [®] | Dark Brown (131) | 53 x 70 x 23 |

the essentials in meal delivery

UPC101 - Insulated Top Loading Camcarriers® To Transport Gastronorm Food Pans

UPC101

- Top-loading food pan carriers hold transport and serve a single full-size pan of hot or cold food.
- Sturdy and durable, seamless polyethylene or polypropylene with thick foam insulation.
- Molded-in handles on all four sides for easy carrying and handling.
- Use with divider bars to hold multiple fractional pans.
- Pans are easy to remove using finger notches.
- Carriers interlock and stack for transporting and storing.



| SPECIFICATIONS | UPC101 |
|-------------------------------|--|
| Compartment Capacity | 3 GN 1/1 - 6,5 cm deep pan or 2 GN 1/1 - 10 cm deep pans or 1 GN 1/1 - 15 cm or 20 cm deep pan |
| Exterior Dimensions W x D x H | 67,5 x 46 x 32 cm |
| Interior Dimensions W x D x H | 55,5 x 33,5 x 21 cm |
| Bulk Capacity* | 38 L |
| Fits Camdolly® | CD100, CD100HB |
| Case KG (Cube M³) | 11 (0,11) |

Case Pack: 1 *Without using food pans.

Colours: Dark Brown (131), Slate Blue (401).



DIVIDER BARS

Used to hold multiple fractional trays.



Shown with dividers and fractional sized food pans.

Note: Place food pans on rails. Pans should not be placed on the floor of a Camcarrier® cavity.



Note: If using metal food pans, cool to 120°C before placing into carriers.



the essentials in warewashing



ADC33 - Adjustable Dish Caddy

- Unlimited Versatility: allows for many different combinations of plates, bowls and trays.
- Holds round, square, oval or custom plates ranging from 11 - 73,6 cm.
- Great capacity with a range of 180 to 480 plates, or 45 to 60 plates per stack.
- Ergonomic Design with handles built flush into either side wall make the ADC33 compact and comfortable to handle.
- Durable, polyethylene exterior will not rust, dent or chip.
- Four each 15,24 cm swivel casters with brakes at each corner.
- One rigid caster in the center of the unit makes it easy to maneuver.



| CODE | DIMENSIONS W x D x H |
|-------|-------------------------|
| ADC33 | 76,2 x 98,43 x 83,82 cm |

Colours: Black (110), Dark Brown (131), Slate Blue (401).

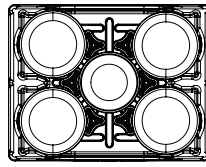

6 dividers,
4 stacks (11-33 cm)
Rounds +
1 stack (17.5-30 cm)
Rounds.

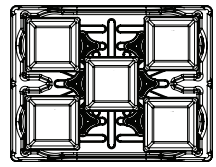

6 dividers, 5 stacks
(24-27,9 cm) Squares.

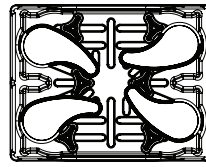

6 dividers,
4 stacks Custom Plates

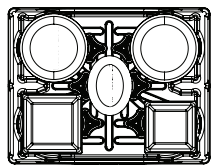

6 dividers,
2 stacks (33,7 cm)
Large Rounds,
1 stack (25,4 cm)
Medium Squares,
1 stack (29,2 cm)
Large Squares,
1 stack (29,2 x 21,9 cm)
Medium Ovals.



ADC33

HOLDING CAPACITY
49,5 cm storage columns
hold 45-60 plates per stack.

EXTREMELY DURABLE
Heavy duty polyethylene
construction protects
china from chipping.
Won't chip, crack or rust.

Cambox® Bussing Boxes

- Cambox compliments the KD Utility Cart by fitting easily and securely on shelves.



| CODE | DESCRIPTION | DIMENSIONS W x D x H |
|---------|---------------------------------|----------------------|
| 1120CBP | Four Compartment Cutlery Box | 28,9 x 52 x 9,5 cm |

Colour: Dark Brown (131).



1120CBP

the essentials in warewashing

KD Utility Cart



- Versatile, strong and durable.
- Lightly textured polypropylene shelves to reduce sliding.
- Stain resistant surface that is easy to clean.
- Four swivelling powder coated casters that are rust resistant.
- Capacity : 180 kg.



BC340KD with BC340KDP Panels.

Each BC340KD shelf holds one full-sized dish rack or two standard bus boxes.



Optional shelf panels can be added at time of assembly to enclose three sides.

Marine rails keep contents in place. 52 x 51 cm working surface.

Sturdy aluminum uprights.

Four powder coated steel swivel casters provide quiet transport and steady maneuvering.

Durable, stain-resistant surface is easy to clean.

| CODE | DESCRIPTION | DIMENSIONS W x D x H |
|-----------|--------------------|-------------------------|
| BC331KD | Service Cart | 83,5 x 41,3 x 96,5 cm |
| BC340KD | Large Utility Cart | 101,5 x 54 x 95 |
| BC340KDP | Panels for BC340KD | 80,3 x 45 x 29,8 |
| BC331KDTC | Trash Container | 33 x 24 x 56 |
| BC331KDSH | Silverware Holder | 33 x 24 x 18,5 |

BC331KD, BC340KD, BC340KDP Colours: Black (110), Speckled Gray (480).

BC331KDTC, BC331KDSH Colour: Black (110).



BC331KD



BC340KD

Tray & Silver Cart

- Use to neatly organize trays and accessories for self-service.
- Includes eight clear Polycarbonate food pans to hold flatware, napkins and non-perishable condiments.
- Protective vinyl cover included.



TC1418

| CODE | DESCRIPTION | DIMENSIONS W x D x H |
|--------|------------------------------|-------------------------|
| TC1418 | Cart with Pans & Vinyl Cover | 82 x 54 x 116 cm |

Colours: Dark Brown (131), Coffee Beige (157).

Vinyl Cover
Use the vinyl cover for sanitary storage (included).



the essentials in warewashing

Washcrate The Complete Washcrate System
Wash, Transport and Store



Ideal Cleaning and Sanitary Storage

The Washcrate System will protect glassware and keep it clean until the next event, therefore, rewashing is eliminated.

No Dirty Hands



No Bugs



No Bacteria



No Dirty Mop Water



No Rodents



Washcrate Cover
seals the Top from external contaminants.



Open Inside Compartments
Provide thorough circulation of water and cleaning solutions and promote quick and thorough drying.



Closed Outer Wall Systems
are designed for superior cleaning keeping water and chemicals inside the rack, reducing waste.

HACCP

EcoSafe



Unsanitary Competition

Opened exterior walls allow contaminants such as dirty water, bacteria, insects, dirt, dust and employee fingers pass through the sidewall, contaminating clean glassware requiring costly rewashing and additional handling.



the essentials in warewashing

Washcrate Accessories

5 x 9 Peg Rack

- Designed to wash standard and oversized deep plates.
- Holds up to ten 25,4 cm deep plates or eighteen 25,4 standard plates.

| CODE | INSIDE HEIGHT | OUTSIDE HEIGHT |
|---------|---------------|----------------|
| PR314 | 6,7 cm | 10,1 cm |
| PR59314 | 6,7 | 10,1 |

Colour: Soft Gray (151).



PR59314

Open End Tray Rack

- Holds cafeteria trays or full-size sheet pans.
- Open-ended on one side for easy placement and removal of trays of all lengths.
- Holds up to nine trays upright.

| CODE | DIMENSIONS W x D x H |
|---------|----------------------|
| OETR314 | 50 x 50 x 8,2 cm |

Colour: Soft Gray (151).



OETR314

Base Rack and Cover

- For pots, pans, bowls and large prep, service and display items.
- Contains items 10,5 cm high max.

| CODE | DESCRIPTION | DIMENSIONS W x D x H |
|-------|-------------|----------------------|
| BR258 | Rack | 50 x 50 x 10,1 cm |

Colours: Sherwood Green (119), Soft Gray (151), Red (163), Blue (168).



BR258

Washcrate Full Cup Rack

- Tilt feature drains water from mug or cup bases for quick and sanitary drying.

| CODE | COMPARTMENT DIMENSIONS |
|--------|------------------------|
| 16C258 | 11,1 x 11,1 cm |

Colour: Soft Gray (151).



16C258

Washcrate Flatware Racks

- Full Rack for cleaning large and small utensils.
- 8 Compartment Basket fits into a Full or Half Size Base Rack.

| CODE | DIMENSIONS W x D x H |
|----------|----------------------|
| FR258 | 50 x 50 x 10,1 cm |
| 8FBNH434 | 18,4 cm Height |

Colour: Soft Gray (151).



FR258

8FBNH434

Camdolly®

- Load capacity of 159 kg.

| CODE | DIMENSIONS W x D x H |
|--------|----------------------|
| CD2020 | 57 x 57 x 21 cm |

Colours: Dark Brown (131), Slate Blue (401).



CD2020

the essentials in warewashing



E1 = Full Size Full Drop
Compartment Extender



E2 = Full Size Half Drop
Compartment Extender



E3 = Full Size Open Extender



E4 = Full Size Full Drop
Stemware Extender

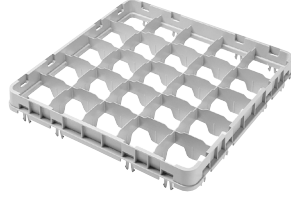

E5 = Full Size Half Drop
Stemware Extender

| CODE | DESCRIPTION | COMPARTMENT | INSIDE RACK HEIGHT | CASE PACK |
|---|-----------------------------------|--------------|--------------------|-----------|
| Full Size Full Drop Extenders – E1 | | | | |
| 9E1 | 9-Compartment Full Drop Extender | 150 x 150 mm | 41 mm | 12 |
| 16E1 | 16-Compartment Full Drop Extender | 111 x 111 | 41 | 12 |
| 25E1 | 25-Compartment Full Drop Extender | 89 x 89 | 41 | 12 |
| 36E1 | 36-Compartment Full Drop Extender | 73 x 73 | 41 | 12 |
| 49E1 | 49-Compartment Full Drop Extender | 62 x 62 | 41 | 12 |
| Full Size Half Drop Extenders – E2 | | | | |
| 9E2 | 9-Compartment Half Drop Extender | 150 x 150 | 41 | 12 |
| 16E2 | 16-Compartment Half Drop Extender | 111 x 111 | 41 | 12 |
| 25E2 | 25-Compartment Half Drop Extender | 89 x 89 | 41 | 12 |
| 36E2 | 36-Compartment Half Drop Extender | 73 x 73 | 41 | 12 |
| 49E2 | 49-Compartment Half Drop Extender | 62 x 62 | 41 | 12 |
| Full Size Open Extender – E3 | | | | |
| E3 | Open Extender | 457 x 457 | 41 | 12 |
| Full Size Full Drop Extenders – E4 (Low Profile) | | | | |
| 16E4 | 16-Compartment Full Drop Extender | 111 x 111 | 41 | 12 |
| 25E4 | 25-Compartment Full Drop Extender | 89 x 89 | 41 | 12 |
| 36E4 | 36-Compartment Full Drop Extender | 73 x 73 | 41 | 12 |
| Full Size Half Drop Extenders – E5 (Low Profile) | | | | |
| 16E5 | 16-Compartment Half Drop Extender | 111 x 111 | 41 | 12 |
| 25E5 | 25-Compartment Half Drop Extender | 89 x 89 | 41 | 12 |
| 36E5 | 36-Compartment Half Drop Extender | 73 x 73 | 41 | 12 |

Exterior Dimensions: 499 x 499 x 51 mm. **Extender Colour:** Soft Gray (151).



ADCRC Compact Adjustable Dish Caddy R-Series



Maximum Performance in a Small Footprint

Features:

- Load bearing capacity 227 kg.
- Holds dishes safely up 29 cm from the floor, with 18 cm of clearance under the unit.
- Dish stacking height 52 cm. Store up to 60 dishes per stack, based on dish type/style.
- One-piece molded body made of highly durable polyethylene, won't rust, crack or dent.
- Four (4) each, plated casters, 2 swivel with brake and 2 fixed, with non-marking highly durable 3 cm polyurethane tread.



| CODE | DIMENSIONS W x D x H |
|-------|----------------------|
| ADCRC | 76 x 76 x 84 cm |

Colour: Slate Blue (401).



Securely Store & Transport Round Dishes From 11,7 to 33 cm.

Adjustable Towers

can accommodate almost any configuration, keeping your dishware secure during transport.



Note: Cannot be used to store square, rectangular or oval plates.

Gain 20% More Floor Space

Compact Design with Unparalleled Capacity

Store more caddies and dishes in the same space, or keep the same quantity of caddies and dishes, and free up valuable space for other uses.

Smooth Maneuvering

Compact square design, with 2 fixed and 2 swivel casters, which means easier transport in and out of storage, up and down ramps and across carpet.

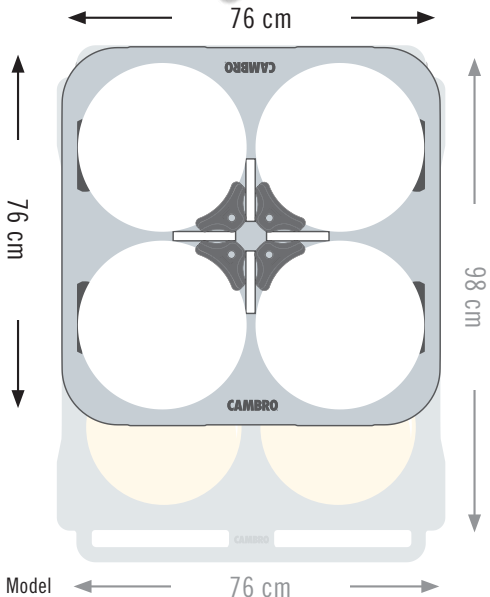

Compared to the Cambro ADC33 Model



SD EXPORTS
SATISFYING DEMAND

SD EXPORTS

Location
Come Visit Us

SRI PETHANATCHI COMPLEX,
THENI, TAMILNADU
625531

FOR CONTACT



+91 9865931583



purchasing@sdexportsindia.com

Follow us on

